

Data Sheet



Article number: 03446050

Description: Fluro Heavy Duty Spherical Plain Bearing GE 50 GW-2RS
Hole Ø50

Note: 50

Measures

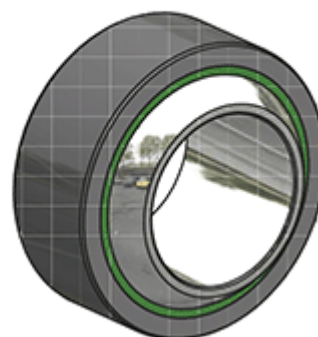
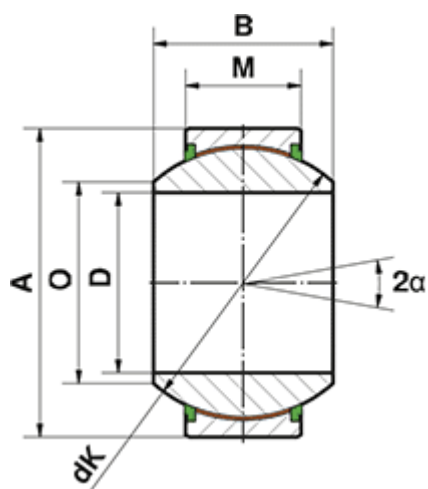

= -	Dynamic load C (kN) = 690
= -	M = 36
= -	O = 57.1
A = 90	Static load C0 (kN) = 1150
a (degrees) = 17	Weight (g) = 1400
B = 56	
D = 50	
dK = 80	